

FWB1685-J

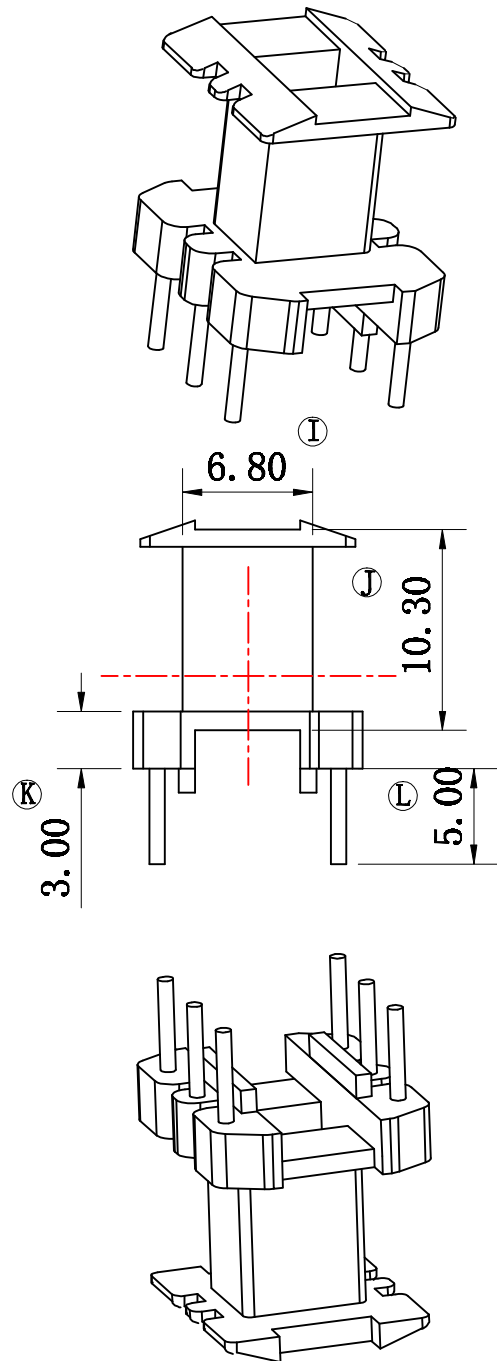
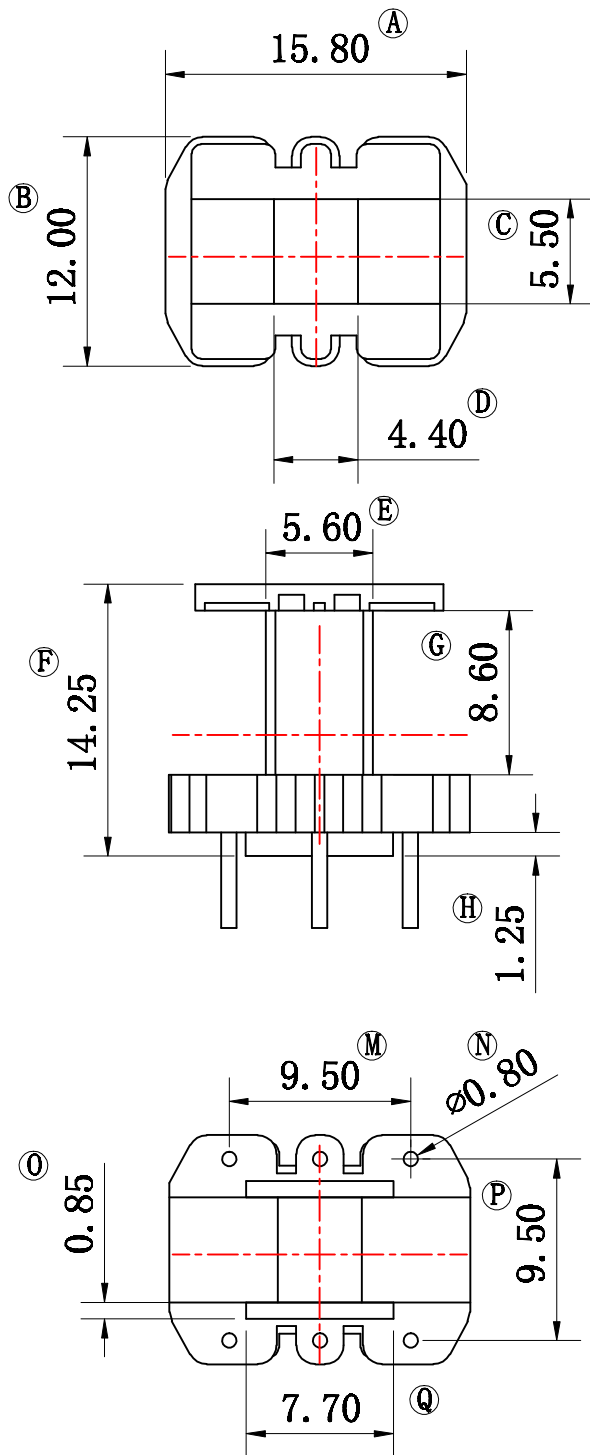

REV	REVISION RECORD	DATE	REV	REVISION RECORD	DATE
A			C		
B			D		
NAME	EE16 3+3P	MATERIAL	PHENOLIC	SCALE	ANGLE $\pm 1^\circ$
DRAWING NO.	FWB1685-J	PIN MATERIAL	CP WIRE	UNIT	m/m REV A
TOLERANCE OF PIN PITCH ± 0.20			HAINING FERRIWO ELECTRONICS CO.,LTD.		
PIN TENSION LOAD kg MN		UL REC: 94V-0	TEL: +86-573-87088701 FAX: +86-573-87081130		
TOLERANCE: 0<L≤4: ±0.2 4<L≤16: ±0.3 16<L≤63: ±0.4			Web: www.ferriwo.com Email: sales@ferriwo.com		